

TOP VIEW

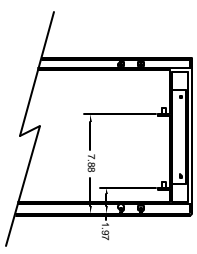

ADJUSTABLE MOUNTING PLATE

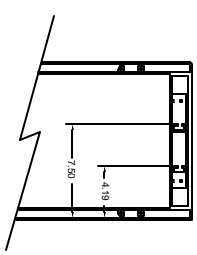

ADJUSTABLE MOUNTING FRAME

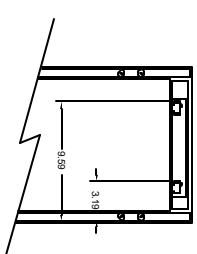

FIXED MOUNTING FRAME

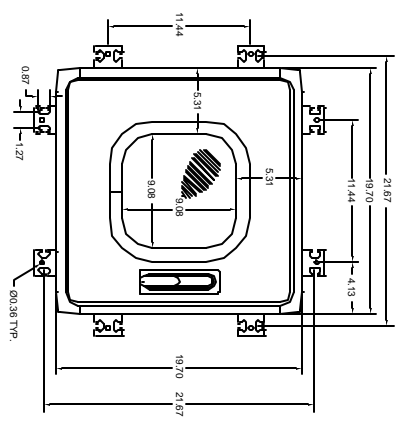

FRONT VIEW

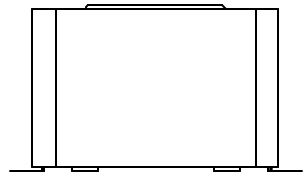

RIGHT SIDE VIEW

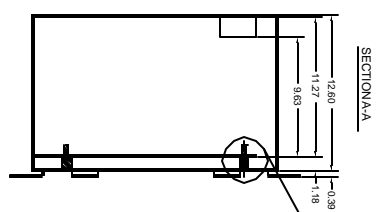

SECTION A-A

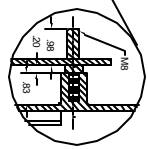

INNER DOOR PANEL

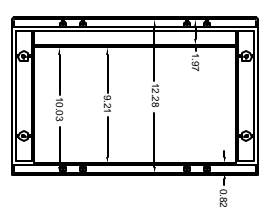

SCALE X 3

THIS DRAWING IS THE PROPERTY OF VYNCKIER SYSTEMS LTD. IT IS TO BE USED ONLY FOR THE PROJECT AND SHALL NOT BE REPRODUCED OR TRANSMITTED IN ANY FORM OR BY ANY MEANS, ELECTRONIC OR MECHANICAL, INCLUDING PHOTOCOPYING, RECORDING, OR BY ANY INFORMATION STORAGE AND RETRIEVAL SYSTEMS. ANY SUCH UNAUTHORIZED USE SHALL BE AT THE USER'S SOLE RISK AND WITHOUT LIABILITY TO VYNCKIER SYSTEMS LTD.

|   |  |  |  |
|---|--|--|--|
| VYNCKIER SYSTEMS LTD.<br>ENCLOSURE SYSTEMS LTD. |  | DATE: 05/28/07<br>DRAWN: KEVIN CHAPMAN<br>DESIGNED: KEVIN CHAPMAN<br>DESIGNED: KEVIN CHAPMAN<br>CHECKED: KEVIN CHAPMAN<br>DATE: 05/28/07 |  |
| VJ SERIES ENCLOSURE<br>VYNCKIER PART# PSG2020A  |  | SIZE: 8" X 10" X 10"<br>DWG. NO.: 1000000000<br>DWG. TITL.: ENCLOSURE<br>SHEET: 3/8  |  |