

TOP VIEW

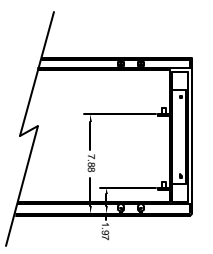

ADJUSTABLE MOUNTING PLATE

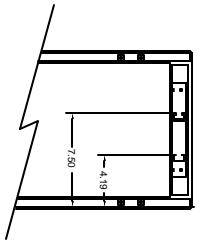

ADJUSTABLE MOUNTING FRAME

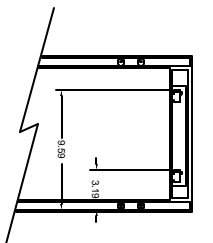

FIXED MOUNTING FRAME

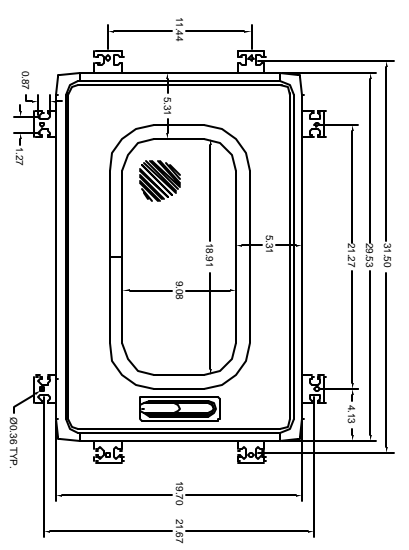

FRONT VIEW

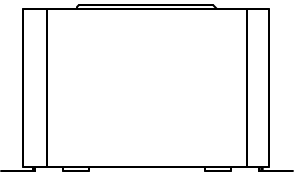

RIGHT SIDE VIEW

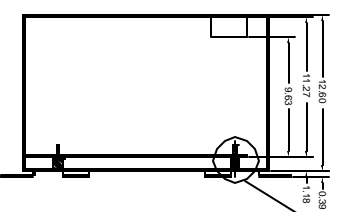

SECTION A-A

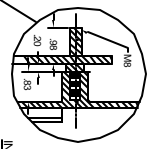

INNER DOOR PANEL

SCALE X3

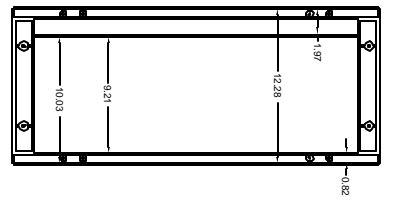

THE DRAWING IS THE PROPERTY OF VYNCKIER ENCLOSURE SYSTEMS LTD. IT IS TO BE USED ONLY FOR THE PURPOSES INDICATED THEREON. IT IS TO BE KEPT IN CONFIDENTIALITY AND SHALL NOT BE REPRODUCED OR TRANSMITTED IN ANY FORM OR BY ANY MEANS, ELECTRONIC OR MECHANICAL, INCLUDING PHOTOCOPYING, RECORDING, OR BY ANY INFORMATION STORAGE AND RETRIEVAL SYSTEM, WITHOUT THE WRITTEN PERMISSION OF VYNCKIER ENCLOSURE SYSTEMS LTD.

VYNCKIER ENCLOSURE SYSTEMS LTD. VJ SERIES ENCLOSURE VYNCKIER PART# PSG2030A		DATE: 04/29/06 DRAWN BY: KEVIN CHANMAN DESIGNED BY: KEVIN CHANMAN	
VYNCKIER ENCLOSURE SYSTEMS LTD. 200 S. 70th OMAHA, NE 68114 402.479.0000 FAX: 402.479.0000 WWW.VYNCKIER.COM		VYNCKIER ENCLOSURE SYSTEMS LTD. 200 S. 70th OMAHA, NE 68114 402.479.0000 FAX: 402.479.0000 WWW.VYNCKIER.COM	
SIZE: B SCALE: FULL	DRAWN BY: KEVIN CHANMAN DATE: 04/29/06	DESIGNED BY: KEVIN CHANMAN DATE: 04/29/06	SHEET: 3 OF 3