

TOP VIEW

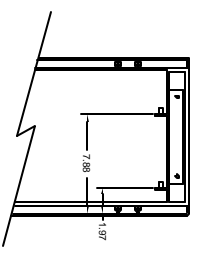

ADJUSTABLE MOUNTING PLATE

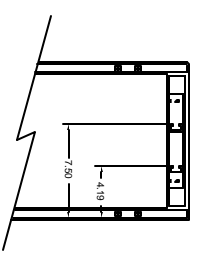

ADJUSTABLE MOUNTING FRAME

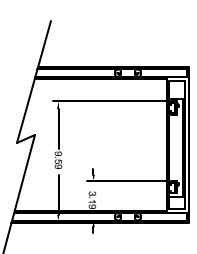

FIXED MOUNTING FRAME

FRONT VIEW

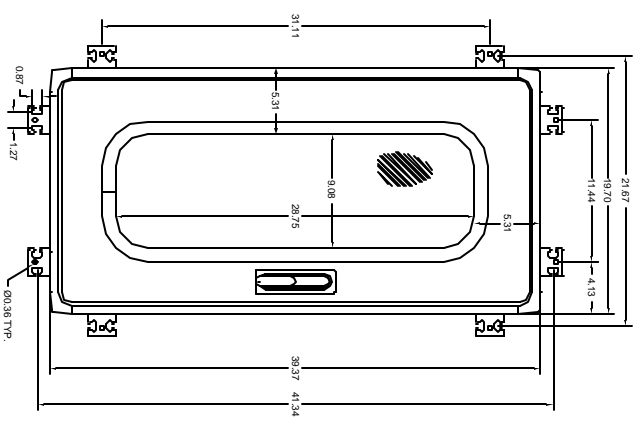

RIGHT SIDE VIEW

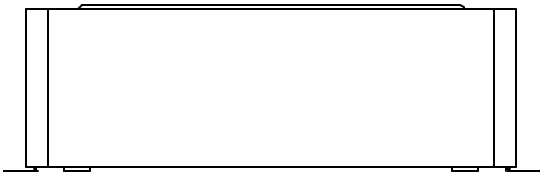

SECTION A-A

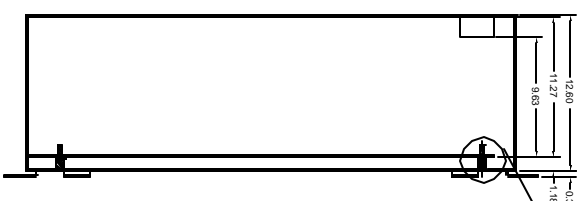

SCALE X3

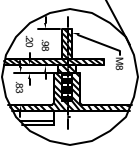

INNER DOOR PANEL

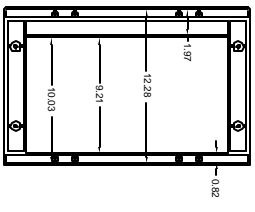

THIS DRAWING IS THE PROPERTY OF VYNCKIER SYSTEMS, INC. AND IS NOT TO BE REPRODUCED OR TRANSMITTED IN ANY FORM OR BY ANY MEANS, ELECTRONIC OR MECHANICAL, INCLUDING PHOTOCOPYING, RECORDING, OR BY ANY INFORMATION STORAGE AND RETRIEVAL SYSTEMS, AND SHALL NOT BE REPRODUCED OR TRANSMITTED IN ANY FORM OR BY ANY MEANS, ELECTRONIC OR MECHANICAL, INCLUDING PHOTOCOPYING, RECORDING, OR BY ANY INFORMATION STORAGE AND RETRIEVAL SYSTEMS, WITHOUT EXPRESS WRITTEN PERMISSION OF VYNCKIER SYSTEMS, INC.

DATE: 05/28/07		DRAWN: KEVIN CHAPMAN		DESIGN: DESKIN	
CHECKED: [Signature]		DATE: 05/28/07		SCALE: FULL	
DESIGNER: [Signature]		DATE: 05/28/07		SCALE: FULL	
DRAWN: KEVIN CHAPMAN		DATE: 05/28/07		SCALE: FULL	
CHECKED: [Signature]		DATE: 05/28/07		SCALE: FULL	
DESIGNER: DESKIN		DATE: 05/28/07		SCALE: FULL	
DATE: 05/28/07		DRAWN: KEVIN CHAPMAN		SCALE: FULL	
CHECKED: [Signature]		DATE: 05/28/07		SCALE: FULL	
DESIGNER: DESKIN		DATE: 05/28/07		SCALE: FULL	
DATE: 05/28/07		DRAWN: KEVIN CHAPMAN		SCALE: FULL	
CHECKED: [Signature]		DATE: 05/28/07		SCALE: FULL	
DESIGNER: DESKIN		DATE: 05/28/07		SCALE: FULL	

VYNCKIER SYSTEMS LTD.
ENCLOSURE
VJ SERIES ENCLOSURE
VYNCKIER PART# PSG4020A